

ABB MEASUREMENT & ANALYTICS | DATA SHEET

VA Master FGM1190

Glass tube variable area flowmeters

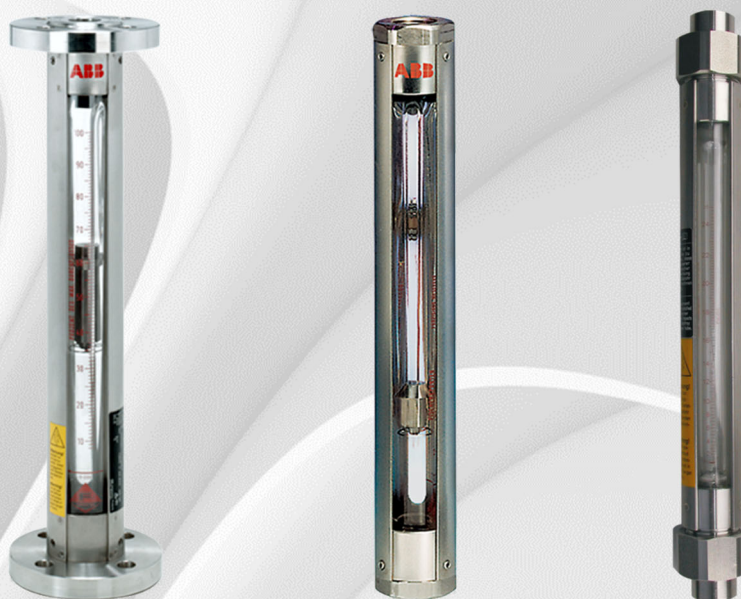

Measurement made easy

Robust and reliable glass tube variable area flowmeter

Function

- Glass tube variable area flowmeter for the measurement of clear liquids and gases

Areas of application

- Suited for flow measurements in many industrial sectors such as apparatus engineering, the food and beverage industry, water treatment systems and the chemicals sector



Product highlights

- Precision tubes with guide surfaces, guide ribs or guide rod
- Standard stainless steel housing
- Easy disassembly of the meter tube due to the O-ring seal
- Meter tube and float can be replaced independently of each other

Important product features

- A magnetically actuated alarm signaling unit size ½ in and up can be attached to the flowmeter

Overview

FGM1190-87	FGM1190-97	FGM1190-98
		
With pipe fitting in accordance with DIN 2950	With vertical female thread connection or threaded spud in accordance with DIN 11851, DIN 405 Part 1 ASME for the food and beverage industry	With flanged connection in accordance with DIN or ASME

In addition to the designs presented above, the FGM1190-95 model with a horizontal female thread connection is available.

Functional description

The VA Master FGM1190 series flowmeters work according to the float principle.

The position of the float in the conical glass meter tube is proportional to the flow. It can be read on the scale fitted to the meter tube.

Four different types of scale can be used:

- Directly readable scale in flow units
- Percentage scale
- DK/DS scale
- Millimeter scale

When using the DK/DS scale a flow rate table is available for the flowmeter. For other operating conditions, the user can create additional tables.

Flowmeters in sizes ½ in to 2 in are provided with a percentage scale in the standard design. The device has a factory plate indicating the flow rate for the display of 100 %. The other scale values can be linearly converted. A special reading curve is therefore not required.

On request, conversion equations for flow calculation for other operating conditions will be made available.

Introduction and basics

Installation conditions

General

The following points are to be considered during installation:

- Prior to installation in the piping, remove the wooden pole used as a transportation lock from the meter tube.
- The glass tube variable area flowmeter is installed vertically in the piping. The measuring media must flow from bottom to top.
- Keep the device as far away as possible from pipe vibrations and powerful magnetic fields.
- The nominal diameter of the piping should be the same as the connection nominal diameter.
- Inlet and outlet sections are not required.
- Avoid pulsating flows and sudden pressure surges.
- Use valves which open slowly.
- If the flowmeter is installed in a pipeline where decommissioning is impossible or inexpedient, a bypass line should be provided.
- For gaseous measuring media, the flowmeter should be installed as close as possible to the pipe constrictions. The nominal diameter of the piping at the outlet of the flowmeter should be measured as small as possible.
- Stop and throttle valves should preferably be attached to the outlet of the flowmeter.
- For liquid measuring media, the nominal diameter of the piping should be dimensioned as large as possible (if economically viable).

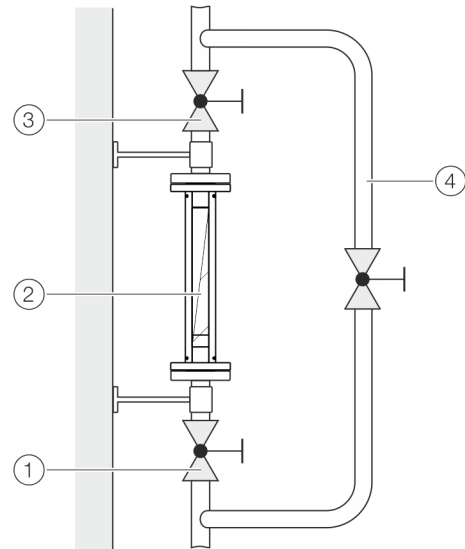

- | | |
|---------------------------|----------------------------|
| ① Stop valve in the inlet | ③ Stop valve in the outlet |
| ② Flowmeter | ④ Bypass line |

Figure 1: Installation of the flowmeter

Installation recommendations

Refer to VDI / VDE Directive 3513 sheet 3, Selection and Installation Recommendations for Variable Area Flowmeters.

Pressure chambers and collecting tanks

If piston pumps or compressors are used for the transport of the measuring media, a pulsating flow of the measurement media must be expected.

In order to reduce the pulsating of the float, the installation of pressure chambers or collecting tanks in the piping before the flowmeter is recommended.

Operating conditions

A variable area flowmeter is specified for a defined set of operating conditions of the measuring medium. For liquids and gases, these are pressure and temperature-related properties (density and viscosity) under operating conditions.

For gases, in particular, this means operating at a specific operating pressure and operating temperature. The specified accuracy of the device always refers to the operating conditions underlying the specification.

Pressure loss

The available operating pressure at the measuring point must be higher than the pressure loss listed for the flowmeter in the specifications.

It is important to also consider the pressure loss downstream from the flowmeter due to losses in the piping and other fittings.

For the design of the device please check the ABB Product Selection Assistant, available at www.abb.com/flow.

Prevention of compression oscillations when measuring gases

During low flow amounts and low operating pressure, so-called compression oscillations of the float can occur.

To prevent self-generated compression oscillations, note the following information from VDI / VDE 3513 Sheet 3:

- Select a flowmeter with the lowest possible pressure loss.
- Minimize the piping length between the flowmeter and the nearest upstream or downstream throttling location.
- Set the limit of the regular measuring range from the usual 10 to 100 % to 25 to 100 %.
- When setting the flow rate value, always start by assuming larger values.
- Increase the operating pressure and consider its effect on the flow rate changes due to the change in gas density in the operating conditions.
- Minimize non-throttled, free volumes upstream and downstream of the device.

Pressure shocks

Especially when measuring gases, it is possible that pressure or shock waves can occur when fast opening solenoid valves are employed and the piping cross-sections are not throttled, or if there are gas bubbles in liquids.

As a result of the sudden expansion of the gas in the piping, the float is forcibly driven against the upper floatstop. Under certain conditions, this can lead to destruction of the device.

Avoid pressure shocks when operating the devices.

Solids content in the measuring medium

Variable area flowmeters have only limited suitability for measuring media containing solids.

Depending on the concentration, particle size and type of solid, increased mechanical abrasion may occur, especially at the critical measuring edge of the float.

In addition, solidified deposits on the float can change its weight and shape.

These effects can lead to erroneous measurement results, depending on the float type.

In general, the use of appropriate filters is recommended in such applications.

For the flow measurement of measuring media containing magnetic particles, we recommend the installation of a magnetic separator upstream of the variable area flowmeter.

... Introduction and basics

Float designs

With a range of around 100,000 possible variable area flowmeter designs, different meter tube float-scale combinations are used.

Float with guide ring

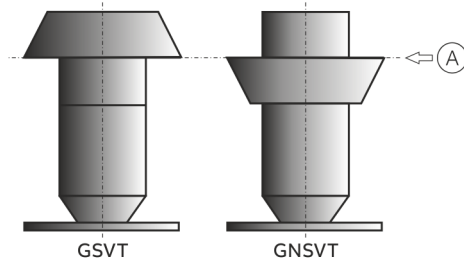

(A) Index markers

Figure 2: Float with guide ring

In combination with three-rib meter tubes and a percentage scale, floats with a guide ring represent the standard design. GSVT type floats are essentially independent of viscosity and available in different materials and weights in the individual device sizes. The reverse head shape of GNSVT type makes it possible to achieve a 25 to 30 % higher flow rate. This float shape is not suited for measuring media with higher viscosities. The VIN numbers in the float selection program must be observed.

The float is guided to the measuring edge and the guide ring in the guide ribs of the meter tube.

Ball float

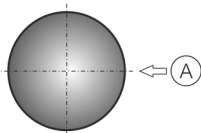

(A) Index markers

Figure 3: Ball float

Ball floats are used to measure small flow rates for meter tube sizes $\frac{1}{16}$ in to $\frac{1}{4}$ in. To achieve as many measuring range levels as possible within a meter tube, ball floats made from various materials of different densities are available.

Float with low pressure loss

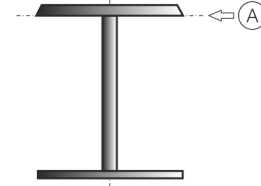

(A) Index markers

Figure 4: Float with low pressure loss

Floats with low pressure loss are specially developed for the measurement of gaseous measuring media at low pressures and ensure an extremely low device pressure loss. They are used in conjunction with three-rib meter tubes.

BL type float

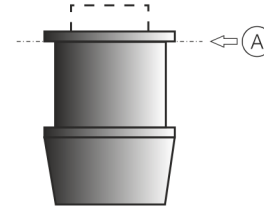

(A) Index markers

Figure 5: BL type float

BL type floats are specially developed for measuring high flow rates with small meter tube sizes.

The float is guided in the guide ribs of the meter tube.

Scale designs

Percentage scale

The linearized percentage scale is the standard scale for three-rib meter tubes and smooth conical meter tubes. It shows the percentage based on the maximum flow rate and extends mostly over a total range of 8 to 100 %. When the operating data, the physical properties of the measuring medium, as well as the float design are known, the maximum flow rates are relatively easy to calculate and convert. Each percentage scale has the accuracy specified by ABB.

Directly readable scale in flow units

The scale directly displays the volume or mass flow rate per unit of time: (e. g. l/h hydrogen, $\text{cm}^3/\text{min H}_2\text{O}$). The scale is only valid for one measuring medium under precisely defined conditions. Certain limits to the universal applicability of the meter tubes are set by the directly readable scale.

Meter tube designs

The meter tube is available with three designs.

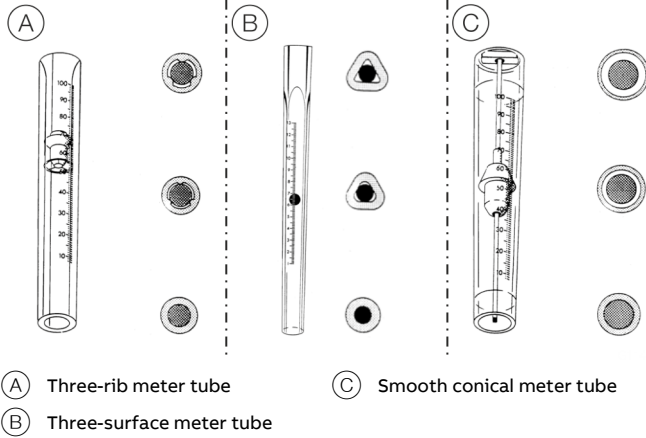

Figure 6: Meter tube versions

Three-rib meter tube

The three-rib meter tube is used as standard for meter tube sizes from 1/2 in to 2 in. In this type of meter tube, the ribs parallel to the unit center lead the float over the entire measuring range.

The small distance between the float and the meter tube ensures identification of the index marker without any problems, even in murky measuring media. The three-rib meter tube is used together with floats with a guide ring.

Three-surface meter tube

The three-surface meter tube is used with smaller meter tube sizes from 1/8 to 1/4 in. Three surfaces run parallel to the center axis in the meter tube that is extended conically in the flow direction. This surface guides the ball-float over the entire measuring range.

The small distance between the float and the meter tube ensures identification of the index marker without any problems, even in murky measuring media. The float is guided precisely in the middle of the meter tube.

Smooth conical meter tube

The smooth conical meter tube is usually only used for extreme operating conditions (e.g. frequent load changes and switching operations).

With a nominal diameter of 1 1/2 in to 2 in, upper range values are produced due to the larger cross-section compared to the three rib meter tube. In a meter tube, the float is guided on a guide rod.

Specification

Scale design

Scale length	Measuring tube sizes
130 mm	1/8 in bis 1/4 in
250 mm	1/2 in bis 2 in

Accuracy class

In accordance with VDI/VDE 3513, sheet 2

Accuracy class	Measuring tube sizes
1,6 % qq = 50 %	1/8 in to 2 in
6 % qq = 50 %	1/2 in to 2 in (with BL type float)

The specified accuracy class of the devices is only achieved by observing the valid operating conditions for the device (operating pressure and operating temperature).

... Specification

Temperature limits °C (°F)

Ambient temperature T_{amb} .

Permissible ambient temperature range:

- Liquid measuring media: -40 to 60 °C (-40 to 140 °F)
- Gas measuring media: -40 to 40 °C (-40 to 104 °F)

Measuring medium temperature T_{medium}

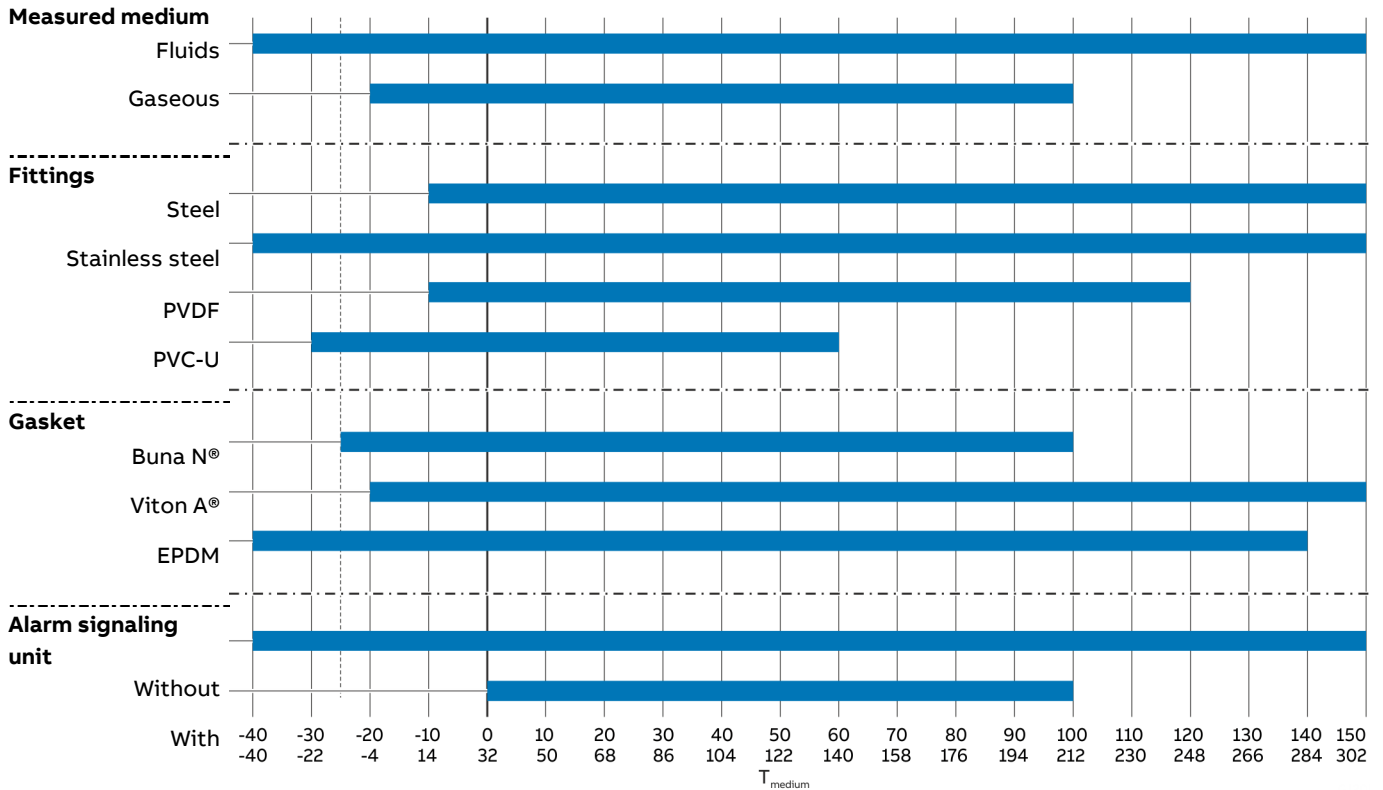

Figure 7: Measuring medium temperature permitted depending on the measuring medium and equipment

For more information about the maximum measuring medium temperature, see **Material load** on page 10.

Process connections

Refer to **Dimensions** on page 13.

Weight

Refer to **Dimensions** on page 13.

Operating pressure

Maximum permissible operating pressure		
Measuring tube sizes	Fluids	Gases
1/8 in, 1/4 in	30 bar (3 MPa / 435.1 psi)	30 bar (3 MPa / 435.1 psi)
1/2 in	21 bar (2.1 MPa / 304.6 psi)	17 bar (1.7 MPa / 246.5 psi)
3/4 in	17 bar (1.7 MPa / 246.5 psi)	13 bar (1.3 MPa / 188.6 psi)
1 in	14 bar (1.4 MPa / 203 psi)	10 bar (1 MPa / 145 psi)
1 1/2 in	9 bar (0.9 MPa / 130.5 psi)	4 bar (0.4 MPa / 58 psi)
2 in	7 bar (0.7 MPa / 101.5 psi)	2 bar (0.2 MPa / 29 psi)

With meter tube sizes of 1 in to 2 in, the maximum permissible operating pressure is reduced by 1 % for each 2 °C (3.6 °F) at operating temperatures of over 95 °C (203 °F) (for liquids).

The reduced pressure values for gas applications are a result of safety considerations.

The resistance of the polycarbonate thermowell is reduced along with increasing temperatures. For this reason, consider the following when measuring gas:

- The listed maximum permissible operating pressure applies for measuring medium temperatures up to 30 °C (86 °F) and ambient temperatures up to 30 °C (86 °F).
- For measuring medium or ambient temperatures over 30 °C (86 °F), the maximum permissible operating pressure is reduced by 1.05 % for each 1 °C (1.8 °F) (for gas).

Materials

Materials for parts wetted with measuring medium

Part / meter tube size	Material	
	Standard	Option
Meter tube	Borosilicate glass	–
Variable area		
1/8 in	Glass, stainless steel 1.4401 (AISI 316), sapphire	Carboloy, tantalum
1/4 in	Glass, stainless steel 1.4401 (AISI 316)	Carboloy, tantalum, sapphire
1/2 in to 2 in	Stainless steel 1.4571 (AISI 316 Ti)	Stainless steel 1.4571 (AISI 316 Ti), PVC
Float stop (inlet)		
1/8 in, 1/4 in	Stainless steel 1.4310 (AISI 301)	–
1/2 in to 2 in	Stainless steel 1.4571 (AISI 316 Ti)	Hastelloy B®, stainless steel 1.4310 (AISI 301)
Float stop (outlet)		
1/8 in to 1/4 in	Stainless steel 1.4310 (AISI 301)	Stainless steel 1.4571 (AISI 316 Ti)
1/2 in to 2 in	Stainless steel 1.4310 (AISI 301)	–
Fittings	Stainless steel 1.4571 (AISI 316 Ti)	Steel, PVC, PVDF
O-rings	Buna N®	Viton A®, ethylen-propylen., silicone

Materials for other parts

Component	Material
Housing	Stainless steel 1.4310 (AISI 301)
Flanges	Stainless steel 1.4310 (AISI 301)

... Specification

Material load

Metal fitting with female thread

Metal fitting with DIN 11851 thread

Types FGM1190-87, -95, -97

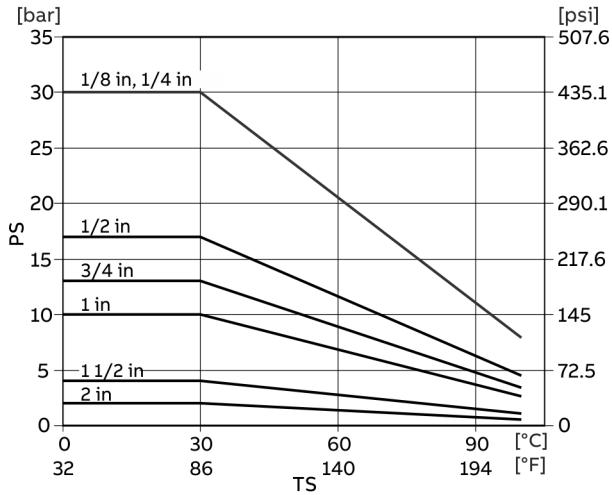

Figure 8: Material load curve for gas

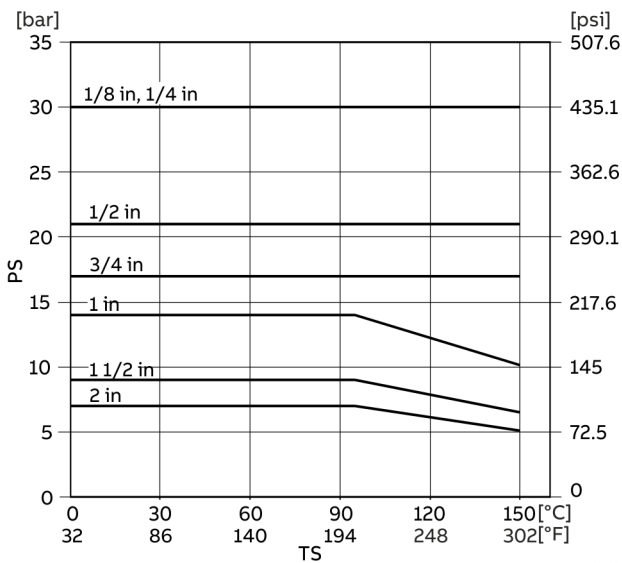

Figure 9: Material load curve for liquids

Plastic fitting

Types FGM1190-97, -98

Plastic fitting with flange PN 40, PN 16, Class 150, 300

Metal fitting with flange PN 40, PN 16, Class 300

Type FGM1190-98

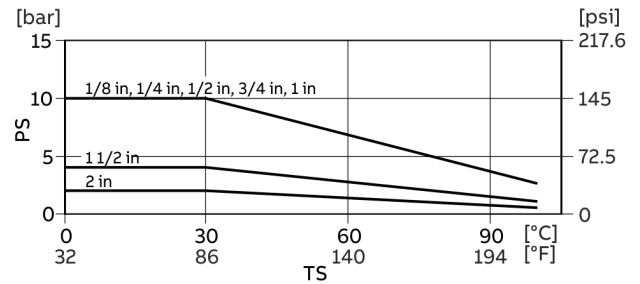

Figure 10: Material load curve for gas

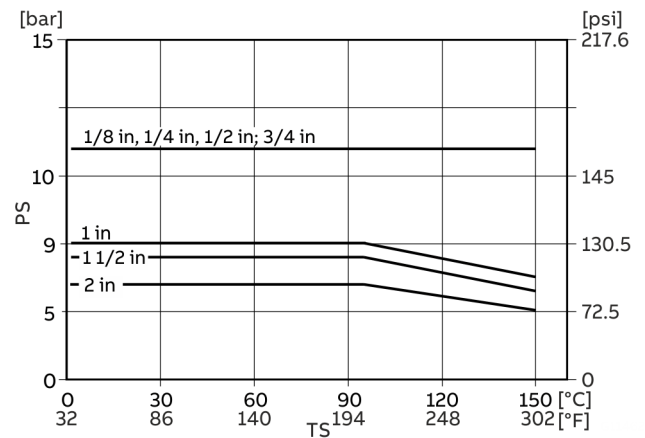

Figure 11: Material load curve for liquids

Metal fitting with flange PN 40, PN 16, CL 300

Type FGM1190-98

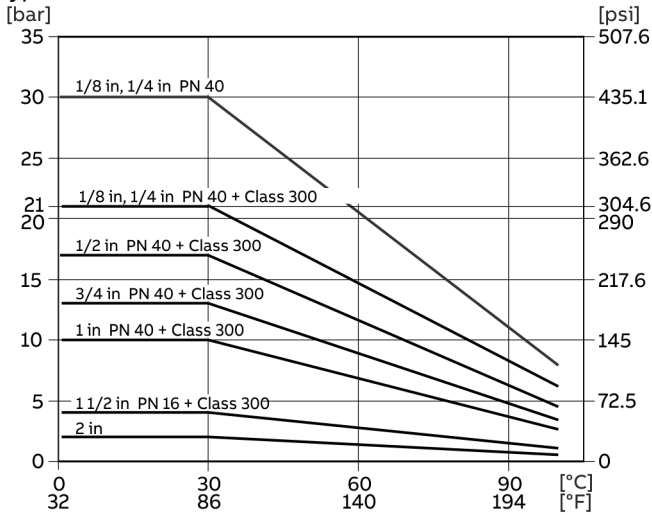

Figure 12: Material load curve for gas

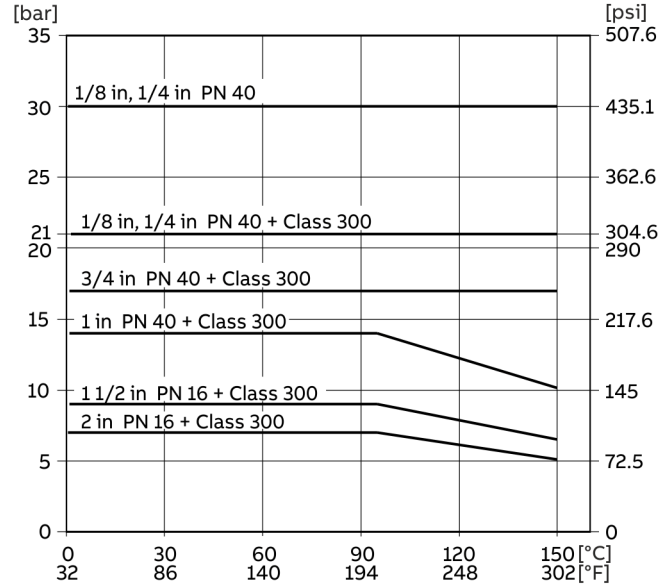

Figure 13: Material load curve for liquids

Measuring range table

The data listed applies to water at 20 °C (68 °F), 1 kg/dm³ (62.43 lb/ft³), 1 mPas (1 cP) and to air at 0 °C (32 °F), 1013 mbar (14.7 psia).

To set up devices for different measurement media or operating conditions please check the ABB Product Selection Assistant, available at www.abb.com/flow.

Process connection	Measuring tube sizes	Minimum measuring range		Maximum measuring range	
		Water	Air	Water	Air
¼ in	⅛ in	0.037 to 0.37 l/h	0.0022 to 0.022 m ³ /h	1 to 10 l/h	0.033 to 0.33 m ³ /h
¼ in	¼ in	0.47 to 4.7 l/h	0.0223 to 0.223 m ³ /h	13 to 132 l/h	0.4 to 4.03 m ³ /h
½ in	½ in	4 to 43 l/h	0.13 to 1.3 m ³ /h	45 to 419 l/h	1.8 to 12.3 m ³ /h
¾ in	¾ in	14 to 144 l/h	0.4 to 4.3 m ³ /h	130 to 1300 l/h	3.8 to 38.7 m ³ /h
1 in	1 in	30 to 310 l/h	0.9 to 9.2 m ³ /h	420 to 2800 l/h	12 to 83 m ³ /h
1 ½ in	1 ½ in	50 to 560 l/h	1.7 to 17.3 m ³ /h	400 to 4800 l/h	12 to 142.5 m ³ /h
2 in	2 in	140 to 1420 l/h	4 to 42.6 m ³ /h	1800 to 9650 l/h	54 to 285 m ³ /h

... Specification

Alarm signaling unit

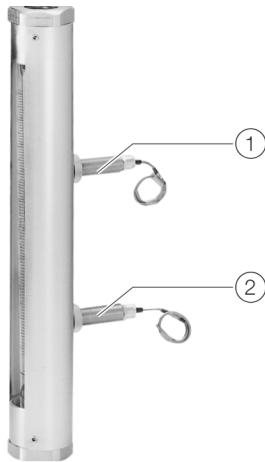

① Max. alarm signalling unit ② Min. alarm signalling unit

Figure 14: Alarm signaling unit 55AX1000

One or two 55AX1000 type alarm signaling units can optionally be attached to the flowmeter housing. The alarm signaling unit is designed as a potential-free contact, actuated by a magnet in the float. An external one or two-channel switching amplifier is required to operate the alarm signaling unit.

Note

- The alarm signaling unit is suited only in connection with type FGM1190 flowmeters with a meter tube size $> \frac{1}{4}$ in
- The alarm signaling unit is suited only in connection with float types G(N)SVT, (N)SVP and BL.

The alarm signaling unit is used in a guide slot in the flowmeter housing and can be adjusted across the entire measuring range.

Specifications

Operating mode	Inert gas switch (reed contact, bistable switching behavior)
Switching behavior	<ul style="list-style-type: none"> • Lower limit value Contact closes in the event of a falling float • Upper limit value Contact closes in the event of a rising float
Switching capacity	Maximum 10 VA, $U_B = 30$ V, 50 / 60 Hz
Permissible ambient temperature	-20 to 60 °C (-4 to 140 °F)
Connection type	Silicone cable SIHF-I 2 x 0.5 mm ² , length 1.75 m (5.74 ft)
IP rating	IP 65 (in accordance with DIN EN 60529)
Material	<ul style="list-style-type: none"> • Alarm signaling unit Brass, nickel-plated • Housing Polyamide
Weight	Approx. 0.7 kg (1.54 lb)

Switching amplifier

Model KF_SR2-Ex1W: 1-channel

Model KF_SR2-Ex2W: 2-channel

Specifications

Power supply	230 V AC, +10 % / -15 %, 45 to 60 Hz 115 V AC, +10 % / -15 %, 45 to 60 Hz 24 V DC, +10 % / -15 %
Output	One or two switching relays with potential-free changeover contacts
Switching capacity	Maximum 250 V, maximum 4 A, maximum 500 VA
Maximum permissible cable length	Between the switching amplifier and alarm signalling unit: 300 m (984 ft)
Permissible ambient temperature range	-20 to 60 °C (-4 to 140 °F)
Electrical connection	Screw terminals, maximum 2.5 mm ² (14 AWG)
Type of assembly	35 mm top-hat rail in accordance with EN 60715:2001
IP rating	IP 20 in accordance with EN 60529
Weight	approx. 150 g (0.3 lb)

Note

See the switching amplifier data sheets for information on Ex-marking and the Ex relevant specifications for the switching amplifiers.

Dimensions

Model FGM1190-97

Screw connection with female thread in accordance with DIN ISO 228 / NPT thread.



Measuring tube sizes	A mm (in)	Diameter B mm (in)	C	D Width across flats mm	Approximate weight kg (lb)
1/8 in bis 1/4 in	260 (10.24)	29 (1.14)	G 1/4 in 1/4 in NPT	27	0.5 (1.1)
1/2 in	405 (15.94)	40 (1.57)	G 1/2 in 1/2 in NPT	36	1.7 (3.8)
3/4 in	405 (15.94)	53 (2.09)	G 3/4 in 3/4 in NPT	50	2.3 (5.0)
1 in	405 (15.94)	58.5 (2.30)	G 1 in 1 in NPT	55	2.7 (6.0)
1 1/2 in	420 (16.54)	78 (3.07)	G 1 1/2 in 1 1/2 in NPT	65	4.4 (9.7)
2 in	420 (16.54)	97 (3.82)	G 2 in 2 in NPT	85	6.5 (14.3)

Threaded spud in accordance with DIN 11851, DIN 405 part 1



Measuring tube sizes	A mm (in)	Diameter B mm (in)	C	Threaded connector	Approximate weight kg (lb)
1/2 in	423 (16.65)	40 (1.57)	Rd 34 × 1/8 in	SC 15	1.7 (3.8)
3/4 in	423 (16.65)	53 (2.09)	Rd 44 × 1/8 in	SC 20	2.3 (5.0)
1 in	423 (16.65)	58.5 (2.30)	Rd 52 × 1/8 in	SC 25	2.7 (6.0)
1 1/2 in	441 (17.36)	78 (3.07)	Rd 65 × 1/8 in	SC 40	4.4 (9.7)
2 in	437 (17.20)	97 (3.82)	Rd 78 × 1/8 in	SC 50	6.5 (14.3)

... Dimensions

Model FGM1190-98

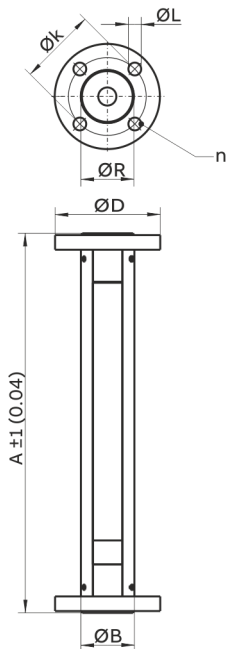

Measuring tube sizes	Flange in accordance with DIN 2501 Weight									
	DN	PN	A mm (in)	Diameter B mm (in)	Diameter D mm (in)	Diameter k mm (in)	Diameter R mm (in)	Diameter L mm (in)	n	approx. kg (lb)
1/8 in bis 1/4 in	10	40	270 (10.63)	29 (1.14)	90 (3.45)	60 (2.36)	32 (1.26)	14 (0.55)	4	1.4 (3.1)
1/2 in	15	40	415 (16.34)	40 (1.57)	95 (3.74)	65 (2.59)	39 (1.54)	14 (0.55)	4	2.4 (5.3)
3/4 in	20	40	415 (16.34)	53 (2.09)	105 (4.13)	75 (2.95)	49 (1.93)	14 (0.55)	4	3.5 (7.7)
1 in	25	40	415 (16.34)	58.5 (2.30)	115 (4.53)	85 (3.35)	58 (2.28)	14 (0.55)	4	4.7 (10.4)
1 1/2 in	40	16	425 (16.73)	78 (3.07)	150 (5.91)	110 (4.33)	74 (2.91)	18 (0.71)	4	7.5 (16.5)
2 in	50	16	425 (16.73)	97 (3.82)	165 (6.50)	125 (4.92)	94 (3.70)	18 (0.71)	4	10.0 (22.0)

Measuring tube sizes	Flange in accordance with ASME CL 150* Weight									
	DN	A mm (in)	Diameter B mm (in)	Diameter D mm (in)	Diameter k mm (in)	Diameter R mm (in)	Diameter L mm (in)	n	approx. kg (lb)	
1/8 in bis 1/4 in	1/2 in	270 (10.63)	29 (1.14)	88.9 (3.50)	60.5 (2.38)	32.0 (1.26)	15.9 (0.63)	4	1.4 (3.1)	
1/2 in	1/2 in	415 (16.34)	40 (1.57)	88.9 (3.50)	60.5 (2.38)	38.8 (1.53)	15.9 (0.63)	4	2.4 (5.3)	
3/4 in	3/4 in	415 (16.34)	53 (2.09)	98.4 (3.87)	69.8 (2.75)	48.8 (1.92)	15.9 (0.63)	4	3.5 (7.7)	
1 in	1 in	415 (16.34)	58.5 (2.30)	108 (4.25)	79.4 (3.12)	57.8 (2.28)	15.9 (0.63)	4	4.7 (10.4)	
1 1/2 in	1 1/2 in	425 (16.73)	78 (3.07)	127 (5.00)	98.4 (3.87)	73.8 (2.91)	15.9 (0.63)	4	7.5 (16.5)	
2 in	2 in	425 (16.73)	97 (3.82)	152 (5.98)	121 (4.76)	93.8 (3.69)	19.0 (0.75)	4	10.0 (22.0)	

Measuring tube sizes	Flange acc. to ASME CL 300 Weight									
	DN	A mm (in)	Diameter B mm (in)	Diameter D mm (in)	Diameter k mm (in)	Diameter R mm (in)	Diameter L mm (in)	n	approx. kg (lb)	
1/8 in bis 1/4 in	1/2 in	270 (10.63)	29 (1.14)	95.2 (3.75)	66.5 (2.62)	32.0 (1.26)	15.9 (0.63)	4	1.4 (3.1)	
1/2 in	1/2 in	415 (16.34)	40 (1.57)	95.2 (3.75)	66.5 (2.62)	38.8 (1.53)	15.9 (0.63)	4	2.4 (5.3)	
3/4 in	3/4 in	415 (16.34)	53 (2.09)	117.5 (4.63)	82.5 (3.25)	48.8 (1.92)	19.0 (0.75)	4	3.5 (7.7)	
1 in	1 in	415 (16.34)	58.5 (2.30)	123.8 (4.87)	88.9 (3.50)	57.8 (2.28)	19.0 (0.75)	4	4.7 (10.4)	
1 1/2 in	1 1/2 in	425 (16.73)	78 (3.07)	156.6 (6.17)	114.3 (4.50)	73.8 (2.91)	22.5 (0.87)	4	7.5 (16.5)	
2 in	2 in	425 (16.73)	97 (3.82)	165.1 (6.50)	127.0 (5.00)	93.8 (3.69)	19.0 (0.75)	8	10.0 (22.0)	

* Problems can arise when using 1/2 in screw heads due to the ratio of bolt hole and housing diameter. If necessary the side of the screw head turned to the housing should be levelled off.

Model FGM1190-87

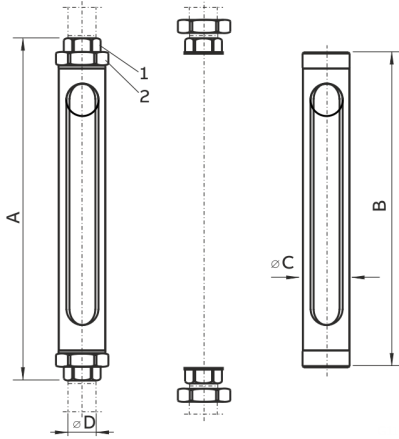

Measuring tube sizes	A		B	Width across flats		Weight
	mm (in)	mm (in)	mm (in)	1	2	approx. kg (lb)
¼ in	270 (10.63)	234 (9.21)	29 (1.14)	18	32	0.6 (1.3)
½ in	415 (16.34)	366 (14.41)	40 (1.57)	26	46	1.4 (3.1)
¾ in	415 (16.34)	366 (14.41)	53 (2.09)	31	55	2.2 (4.9)
1 in	420 (16.54)	366 (14.41)	58.5 (2.30)	38	65	2.9 (6.4)
1 ½ in	455 (17.91)	386 (15.20)	78 (3.07)	54	85	4.7 (10.4)
2 in	460 (18.11)	386 (15.20)	97 (3.82)	67	105	6.8 (15)

Model FGM1190-95

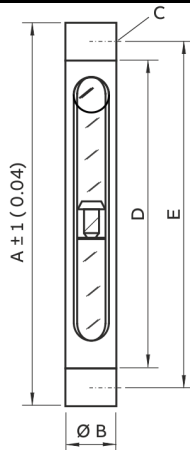

Measuring tube sizes	A	Diameter B	C	D	E	Weight
	mm (in)	mm (in)	mm (in)	mm (in)	mm (in)	approx. kg (lb)
½ in	470	40 (1.57)	G ½ in	383	430	1.4 (3.1)
¾ in	490	53 (2.09)	G ¾ in	379	440	2.2 (4.9)
1 in	490	58.5 (2.30)	G 1 in	376	440	2.9 (6.4)

... Dimensions

Accessories

Needle valves

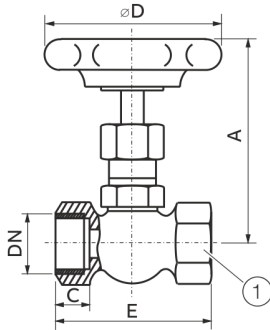

Figure 15: Brass needle valve

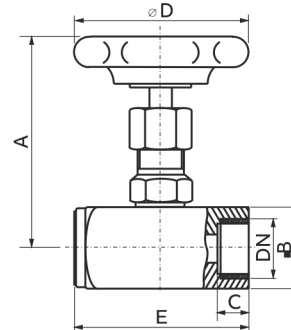

Figure 16: Stainless steel needle valve

Needle valves for installation in the piping before or after the flowmeter. Valves in the in-line housing with female thread connections. For ordering information, see **Ordering information needle valves** on page 27.

Drawing	Material	Pressure rating	Temperature
Figure 15	Brass	PN 100	maximum 100 °C (212 °F)
Figure 16	Stainless steel 1.4571 (AISI 316Ti)	PN 200	maximum 180 °C (356 °F)

Brass needle valve Figure 15

DN	Ø D mm (in)	A mm (in)	C mm (in)	E mm (in)	Width across flats mm
G ¼ in	50 (1.97)	72 (2.83)	10 (0.39)	50 (1.97)	22
G ½ in	63 (2.48)	72 (2.83)	12 (0.47)	55 (2.17)	25
G ¾ in	63 (2.48)	95 (3.74)	14 (0.55)	67 (2.64)	32
G 1 in	90 (3.54)	130 (5.12)	17 (0.67)	74.5 (2.93)	40

Stainless steel needle valve Figure 16

DN	Ø D mm (in)	A mm (in)	B mm (in)	C mm (in)	E mm (in)
G ¼ in	50 (1.97)	72 (2.83)	25 (0.98)	13 (0.51)	50 (1.97)
G ½ in	63 (2.48)	72 (2.83)	30 (1.18)	16 (0.63)	60 (2.36)
G ¾ in	63 (2.48)	95 (3.74)	35 (1.38)	18 (0.71)	75 (2.95)
G 1 in	90 (3.54)	130 (5.12)	45 (1.77)	22 (0.87)	100 (3.94)
¼ in NPT	50 (1.97)	72 (2.83)	25 (0.98)	13 (0.51)	50 (1.97)
⅜ in NPT	50 (1.97)	72 (2.83)	25 (0.98)	13 (0.51)	55 (2.17)
½ in NPT	63 (2.48)	72 (2.83)	30 (1.18)	16 (0.63)	60 (2.36)

Ex-relevant specifications for operation in zones 2, 22

The glass tube variable area flowmeter can be used without further restrictions in the hazardous area of Zone 2 and Zone 22.

Flowmeter Ex marking

II 3G Ex h T6...T3 Gc

II 3D Ex h T6...T3 Dc

Ta= -40...+60°C

Surface temperature

Notice: The maximum surface temperature of the device corresponds to the maximum measuring medium temperature (if this is higher than the ambient temperature). If there are uncertainties regarding the maximum measuring medium temperature, the corresponding security surcharges for the maximum surface temperature when using the device are included in the calculations.

D55AX alarm signaling unit Ex marking

II 3G ec IIC T6...T3 Gc

The rated voltage of the alarm signaling unit is $U_M = 60 \text{ V AC}$, 75 V DC .

Electrical connection for the alarm signaling unit

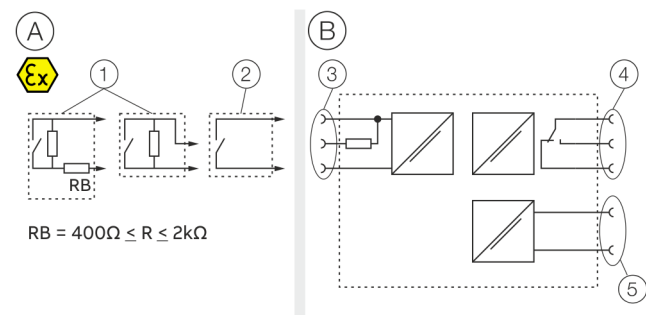

- | | |
|--|--------------------------------------|
| (A) Hazardous area | (2) D55AX alarm signalling unit |
| (B) Non-hazardous area | (3) Switching amplifier input |
| (1) Alarm signaling unit in NAMUR wiring | (4) Switching amplifier output |
| | (5) Switching amplifier power supply |

Figure 17: Connection of an alarm signalling unit to a switching amplifier (example)

The circuits (between the alarm signalling units and the switching amplifier) are intrinsically safe. The switching amplifier itself must be mounted outside the hazardous area.

Information for safe operation in potentially explosive atmospheres

When operating in hazardous areas, observe the following points and instructions.

Assembly / Commissioning

When installing the flowmeter, ensure that there are no external mechanical influences on the flowmeter.

Operation

- Make sure that the chemical resistance and temperature resistance of the gaskets are observed.
- Make sure that the permissible operating conditions and ambient conditions are observed.
- Make sure that the measuring medium does not contain any corrosive metal particles.
- Make sure that the liquid measuring media do not have any gas inclusions.
- Avoid pulsating flow of the measuring media.
- Avoid compression oscillations, see **Prevention of compression oscillations when measuring gases** on page 5.

Maintenance / Repair

Ensure that only original parts are used during maintenance and repair work.

- Make sure that there are no solid particles or loose parts in the piping.
- When cleaning the plastic thermowell, use a moist cleaning cloth only to avoid the risk of explosion due to electrostatic charging.

Ordering Information

FGM1190-87

Glass Tube Variable Area Flowmeter, with screw joint

FGM1190-87	D10A11	XX	X	X	X	X	X	XX	X	X	X	X	X	X	X	X	XXX	XX	X
Connection																			
Pipe union (¼ to 2 in)		87																	
Design Level																			
(Specified by ABB)			X																
Instrument Design																			
Standard				A															
Alarm Unit																			
Without																			
Prepared for alarm																			
Fitting Material																			
AISI 316Ti SST (1.4571)																			
Applications																			
Fluid																			
Gas																			
Oxygen																			
Mounting / Protection Shield																			
Pipe mounting / With																			
O-Ring Materials																			
Buna N®																			
Viton A®																			
Ethylene-Propylene																			
Connection Type																			
Pipe connection																			
Connection Size / Metering Tube Size																			
¼ in / ⅙ in																			
¼ in / ¼ in																			
½ in / ½ in																			
¾ in / ¾ in																			
1 in / 1 in																			
1-½ in / 1-½ in																			
2 in / 2 in																			
Floatstop Materials																			
(Specified by ABB)																			
Accuracy																			
Standard																			
Calibration																			
Viscosity calculation +/- 4 % of max. flow																			

* Alarm signalling unit D55AX, ordering information see chapter **Main Ordering information alarm signalling unit type D55AX** on page 26.

** Not available with alarm signalling unit.

*** ½ to 2 in

Continued on next page

FGM1190-87	X	X	XXX	XX	X
Name Plate					
German	D				
English	E				
Certificates					
Standard			A		
Inspection certificate 3.1 acc. EN 10204			B		
Pressure test acc. AD2000			C		
Material certificate 3.1 acc. EN 10204 with pressure test acc. AD2000			D		
Others			Z		
Tube / Float Combination					
(Specified by ABB)				XXX	
Float Material					
AISI 316Ti SST (1.4571)					01*
PVC					08*
Glass					40**
Saphir					41**
AISI 316L SST (1.4404)					42**
Carboloy					43**
Tantalum					44**
Scale Design					
Direct reading scale					A
Percentage scale					P*

* ½ to 2 in

** ⅙ to ¼ in

... Ordering Information

FGM1190-95

Glass Tube Variable Area Flowmeter, with horizontal screw connection

FGM1190-95	D10A11	XX	X	X	X	X	X	XX	X	X	X	X	X	X	X	X	XXX	XX	X
Connection																			
Horizontal screwed connection (½ to 1 in)		95																	
Design Level																			
(Specified by ABB)			X																
Instrument Design																			
Standard				A															
Alarm Unit																			
Without						0													
Prepared for alarm						1*													
Fitting Material																			
AISI 316Ti SST (1.4571)								T											
Applications																			
Fluid								1											
Gas								2											
Oxygen								3											
Mounting / Protection Shield																			
Pipe mounting / With										40									
Rear panel mounting / With										60									
O-Ring Materials																			
Buna N®													N						
Viton A®													A						
Ethylene-Propylene													F						
Connection Type																			
Cylindric pipe thread														1					
NPT pipe thread														6					
Connection Size / Metering Tube Size																			
½ in / ½ in															2				
¾ in / ¾ in															3				
1 in / 1 in															4				
Floatstop Materials																			
(Specified by ABB)																X			
Accuracy																			
Standard																			A
Calibration																			B
Viscosity calculation ±4 % of max. flow																			C

* Alarm signalling unit D55AX, ordering information see chapter **Main Ordering information alarm signalling unit type D55AX** on page 26.

Continued on next page

FGM1190-95	X	X	XXX	XX	X
Name Plate					
German	D				
English	E				
Certificates					
Standard		A			
Inspection certificate 3.1 acc. EN 10204		B			
Pressure test acc. AD2000		C			
Material certificate 3.1 acc. EN 10204 with pressure test acc. AD2000		D			
Others		Z			
Tube / Float Combination					
(Specified by ABB)			XXX		
Float Material					
AISI 316Ti SST (1.4571)				01	
PVC				08	
Scale Design					
Direct reading scale					A
Percentage scale					P

... Ordering Information

FGM1190-97

Glass Tube Variable Area Flowmeter, with vertical screw connection

FGM1190-97	D10A11	XX	X	X	X	X	X	XX	X	X	X	X	X	X	X	XXX	XX	X
Connection																		
Vertical screwed connection ¼ to 2 in	97																	
Design Level																		
(Specified by ABB)		X																
Instrument Design																		
Standard				A														
Pole guide (½ to 2 in)				P														
Alarm Unit																		
Without					0*													
Prepared for alarm					1*													
Fitting Material																		
AISI 316Ti SST (1.4571)								T										
PVC								C**										
PVDF								F										
Applications																		
Fluid									1									
Gas									2									
Oxygen									3									
Mounting / Protection Shield																		
Pipe mounting / With										40								
Rear panel mounting / With										60								
O-Ring Materials																		
Buna N®												N						
Viton A®												A						
Ethylene-Propylene												F						
Connection Type																		
Pipe thread													1					
Thread DIN 11851													2**					
Thread NPT													6					
Connection Size / Metering Tube Size																		
¼ in / ⅙ in														8***				
¼ in / ¼ in														1***				
½ in / ½ in														2				
¾ in / ¾ in														3				
1 in / 1 in														4				
1-½ in / 1-½ in														5				
2 in / 2 in														6				

* Alarm signalling unit D55AX, ordering information see chapter **Main Ordering information alarm signalling unit type D55AX** on page 26.

** ½ to 2 in

*** Not available with alarm signalling unit.

Continued on next page

FGM1190-97	X	X	X	X	XXX	XX	X
Floatstop Materials							
(Specified by ABB)	X						
Accuracy							
Standard		A					
Calibration		B					
Viscosity calculation ±4 % of max. flow		C*					
Name Plate							
German				D			
English				E			
Certificates							
Standard					A		
Inspection certificate 3.1 acc. EN 10204					B		
Pressure test acc. AD2000					C		
Material certificate 3.1 acc. EN 10204 with pressure test acc. AD2000					D		
Others					Z		
Tube / Float Combination							
(Specified by ABB)					XXX		
Float Material							
AISI 316Ti SST (1.4571)							01*
PVC							08*
Glass							40**
Saphir							41**
AISI 316L SST (1.4404)							42**
Carboloy							43**
Tantalum							44**
Scale Design							
Direct reading scale							A
Percentage scale							P*

* ½ to 2 in

** ⅜ to ¼ in

... Ordering Information

FGM1190-98

Glass Tube Variable Area Flowmeter, with vertical flange connection

FGM1190-98	D10A11	XX	X	X	X	X	X	XX	X	X	X	X	X	X	X	XXX	XX	X
Connection																		
Vertical flanged connection (½ in to 2 in)	98																	
Design Level																		
(Specified by ABB)		X																
Instrument Design																		
Standard			A															
Alarm Unit																		
Without						0*												
Prepared for alarm						1*												
Fitting Material																		
AISI 316Ti SST (1.4571)																		T
PVC (½ in to 2 in)																		C
PVDF (½ in to 2 in)																		F
Applications																		
Fluid																		1
Gas																		2
Oxygen																		3
Mounting / Protection Shield																		
Pipe mounting / With																		40
O-Ring Materials																		
Buna N																		N
Viton A																		A
Ethylene-Propylene																		F
Connection Type																		
Flange DIN 2501																		4**
Flange ASME CL 300																		5
Flange ASME CL 150																		7
Connection Size / Meter Tube Size																		
DN 10 (½ in) / ⅜ in																		8***
DN 10 (½ in) / ¼ in																		1***
DN 15 (½ in) / ½ in																		2
DN 20 (¾ in) / ¾ in																		3
DN 25 (1 in) / 1 in																		4
DN 40 (1-½ in) / 1-½ in																		5
DN 50 (2 in) / 2 in																		6

* Alarm signalling unit D55AX, ordering information see chapter **Main Ordering information alarm signalling unit type D55AX** on page 26.

** PN 40 (1-½ in and 2 in = PN 16)

*** Not available with alarm signalling unit.

Continued on next page

Main ordering information FGM1190-98	X	X	X	X	XXX	XX	X
Floatstop Materials (Specified by ABB)	X						
Accuracy							
Standard		A					
Calibration		B					
Viscosity calculation ± 4 % of max. flow		C*					
Name Plate							
German				D			
English				E			
Certificates							
Standard					A		
Inspection certificate 3.1 acc. EN 10204					B		
Pressure test acc. AD2000					C		
Material certificate 3.1 acc. EN 10204 with pressure test acc. AD2000					D		
Others					Z		
Tube / Float Combination (Specified by ABB)						XXX	
Float Material							
AISI 316Ti SST (1.4571)							01*
PVC							08*
Glass							40**
Saphir							41**
AISI 316L SST (1.4404)							42**
Carboloy							43**
Tantalum							44**
Scale Design							
Direct reading scale							A
Percentage scale							P*
* $\frac{1}{2}$ in to 2 in							
** $\frac{1}{8}$ in to $\frac{1}{4}$ in							

Declarations and certificates

Designation	Ordering number
FGM declaration of compliance in accordance with EN 10204-2.1	BZ-11-0001-SDM
FGM declaration of compliance in accordance with EN 10204-2.2	BZ-11-0002-SDM
FGM test report dye-penetrant technique DIN 54152	BZ-11-0010-00-SDM
FGM declaration of compliance for refurbished Ex-equipment	BZ-13-1006-SDM
FGM calibration certificate including declaration of compliance for accuracy (not DN 100)	BZ-15-0016-SDM
FGM declaration of compliance for accuracy	BZ-15-0018-02-SDM
FGM declaration of compliance for visual inspection and dimension check	BZ-15-0040-SDM

... Ordering Information

Accessories

Main Ordering information alarm signalling unit type D55AX

Alarm Unit TypD55AX	X	X	X	X	X
Limit Alarm					
High limit value	1				
Low limit value	2				
High and low limit value	3				
Transistor Switch Amplifier					
Without		0			
With type KFA_-SR2-Ex1.W		1*			
With type KFA_-SR2-Ex2.W		2**			
Power Supply for Transistor Switch Amplifier					
Without			0		
115 V AC 50 / 60 Hz			1		
230 V AC 50 / 60 Hz			2		
24 V DC			3		
Design Level					
(Specified by ABB)					x
Suitable for					
Model 10A1187D, 10A1190D, 10B1190D					F

* For single alarm (high or low)

** For double alarm (high and low)

Ordering information switching amplifier

Designation	Ordering number
Switching amplifier model KFA5-SR2-Ex1.W, single alarm, 115 V AC 50 / 60 Hz	D163A011U01
Switching amplifier model KFA6-SR2-Ex1.W, single alarm, 230 V AC 50 / 60 Hz	D163A011U02
Switching amplifier model KFD2-SR2-Ex1.W, single alarm, 24 V DC	D163A011U03
Switching amplifier model KFA5-SR2-Ex2.W, double alarm, 115 V AC 50 / 60 Hz	D163A011U04
Switching amplifier model KFA6-SR2-Ex2.W, double alarm, 230 V AC 50 / 60 Hz	D163A011U05
Switching amplifier model KFD2-SR2-Ex2.W, double alarm, 24 V DC	D163A011U06

Ordering information needle valves

Designation	Ordering number
Brass needle valve	
Needle valve, material brass, G ¼ in, separate	1D125D1004
Needle valve for oxygen applications, material brass, G ¼ in, separate	D125D001U01
Needle valve, material brass, G ½ in, separate	1D125D1005
Needle valve for oxygen applications, material brass, G ½ in, separate	D125D001U02
Needle valve, material brass, G ¾ in, separate	1D125D1006
Needle valve for oxygen applications, material brass G ¾ in, separate	D125D001U03
Needle valve, material brass, G 1 in, separate	1D125D1017
Needle valve for oxygen applications, material brass, G 1 in, separate	D125D001U04
Stainless steel needle valve	
Needle valve, material 1.4571 (AISI 316Ti), G ¼ in, separate	1D125D1001
Needle valve, material 1.4571 (AISI 316Ti), G ½ in, separate	1D125D1002
Needle valve, material 1.4571 (AISI 316Ti), G ¾ in, separate	1D125D1003
Needle valve, material 1.4571 (AISI 316Ti), G 1 in, separate	1D125D1019
Needle valve, material 1.4571 (AISI 316Ti), ⅜ in NPT, separate	D125D003U01
Needle valve, material 1.4571 (AISI 316Ti), ¼ in NPT, separate	D125D003U02
Needle valve, material 1.4571 (AISI 316Ti), ½ in NPT, separate	D125D003U03

Trademarks

Buna-N is a registered trademark of DuPont Dow Elastomers.

Hastelloy B-3 is a Haynes International trademark

Viton is a DuPont de Nemours trademark

Sales



Service



ABB Limited**Measurement & Analytics**

Howard Road, St. Neots
Cambridgeshire, PE19 8EU
UK

Tel: +44 (0)870 600 6122

Fax: +44 (0)1480 213 339

Email: enquiries.mp.uk@gb.abb.com

ABB Inc.**Measurement & Analytics**

125 E. County Line Road
Warminster, PA 18974
USA

Tel: +1 215 674 6000

Fax: +1 215 674 7183

ABB Automation Products GmbH**Measurement & Analytics**

Schillerstr. 72
32425 Minden
Germany

Tel: +49 571 830-0

Fax: +49 571 830-1806

abb.com/flow

We reserve the right to make technical changes or modify the contents of this document without prior notice. With regard to purchase orders, the agreed particulars shall prevail. ABB does not accept any responsibility whatsoever for potential errors or possible lack of information in this document.

We reserve all rights in this document and in the subject matter and illustrations contained therein. Any reproduction, disclosure to third parties or utilization of its contents – in whole or in parts – is forbidden without prior written consent of ABB.